

LUXOR COLLECTION



Before Luxor...!!!





The new studied dimensions + the lightness of the structure with integrated «invisible» handles multiply the display space and optimise visibility from the first to the last level!

Won over at first sight!



SPECIAL FEATURES: THE DETAILS THAT MAKE THE DIFFERENCE



- Display compartment in tempered glass with led lighting
- Lower structure in special anti finger print steel, without frontal holes. Invisible wheels!!
- Panel control board with HACCP alarms



Two dimensions available: length
80,5 cm
(mod. ...8Q) and, for the Slim
models, length
60 cm (mod. ...6Q)

LUXOR NEW COLORS



LUXOR BLACK

Display compartment in glazed tempered glass.

Luxor Black, mod. ...A, with black screen-silk printed glass

High brightness LED bar lighting, front panel on the back of the door and on internal ceiling element in the display compartment

Luxor Black, mod. ...A in special black polished steel

LUXOR SILVER

Display compartment in glazed tempered glass.

Luxor Silver, mod. ...X, with grey screen-silk printed glass

High brightness LED bar lighting, front panel on the back of the door and on internal ceiling element in the display compartment

Luxor Silver, mod. ...X in special grey polished steel



LUXOR WHITE

Luxor White, mod. ...V : display compartment entirely in extra-clear tempered glass with white screen printing

Luxor White, mod. ...V: lower structure in extra-clear white glass with integrated capacitive control panel with HACCP alarms

High brightness LED bar lighting, front panel on the back of the door and on internal ceiling element in the display compartment



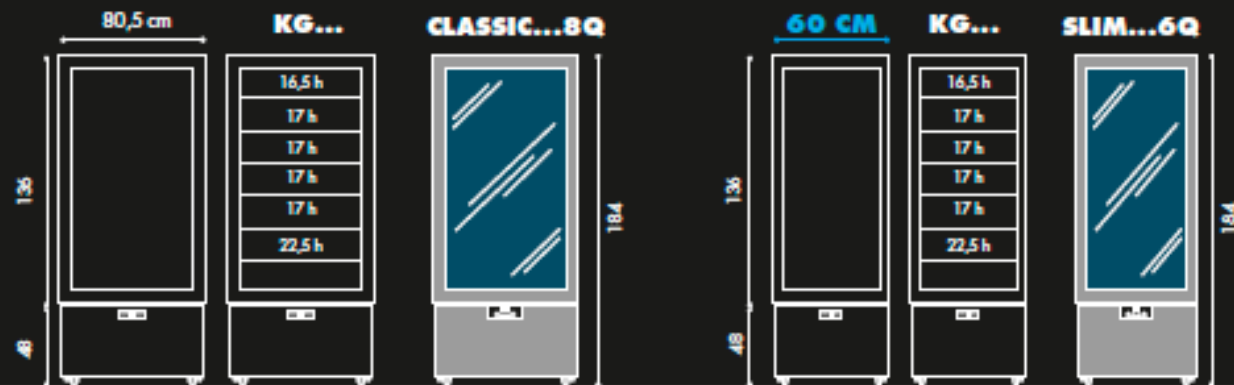

KG8Q	KP8Q	KD8Q	KC8Q	KG6Q	KP6Q	KD6Q
-25 / -15	+2 / +10	-22/+5	+14 / +16	-25 / -15	+2/+10	-22/+5
+30	+30	+30	+30	+30	+30	+30
S				S		
75	70	65 ÷ 40	40 ÷ 44 ***	75	70	65 ÷ 40
manuale manual	A ad aria by air	A a gas caldo by hot gas	A ad aria by air	manuale manual	A ad aria by air	A a gas caldo by hot gas
1	5	5	5	1	5	5
5				5		
65x46	70x47	70x47	70x47	45x46	49x47	49x47
80,5x64,5x184	80,5x64,5x184	80,5x64,5x184	80,5x64,5x184	60x64,5x184	60x64,5x184	60x64,5x184
490	490	490	490	324	324	324
217/242	211/236	232/256	211/236	197/222	191/216	212/236
1000/1140	600/668	1100/1140	570/668	1000/869	600/596	1100/869

Fluido refrigerante • Refrigerant fluid – R404A

⚠ KP...; KC...; KD...: possibilità di carico per ogni singolo ripiano in vetro fino a 12 kg; a richiesta disponibile accessorio KSR25KG: kit supporto anteriore ripiani in vetro per sostegno fino a 25 kg. • possibility of loading up to 12 kg per shelf; on request available the accessorio KSR25KG: front bearing kit for shelves, to load up to 25 kg.

LUXOR NEW COLORS



	KG8QX...A..V	KP8QX...A..V	KD8QX...A..V	KC8QX...A..V
	-25 / -15	+2 / +10	-22/+5	+14 / +16
	+30	+30	+30	+30
	S			
	75	70	65 ÷ 40	40 ÷ 44
	manuale * manual	A ad aria by air	A a gas caldo by hot gas	A ad aria by air
	1	5	5	5
	5	-	-	-
	65x46	70x47	70x47	70x47
	80,5x64,5x184	80,5x64,5x184	80,5x64,5x184	80,5x64,5x184
	490	490	490	490
	228/253	222/247	243/267	222/247
	1050/1140	650/668	1250/1140	620/668

Fluido refrigerante * Refrigerant fluid - R404A

⚠ KP...; KC...; KD...: possibilità di carico per ogni singolo ripiano in vetro fino a 12 kg; a richiesta disponibile accessorio KSR25KG: kit supporto anteriore ripiani in vetro per sostegno fino a 25 kg. * possibility of loading up to 12 kg per shelf; on request available the accessorio KSR25KG: front bearing kit for shelves, to load up to 25 kg.















LUXOR DOUBLE





reddot design award
honourable mention 2012

- The Red dot design award is one of the leading international design competitions: in 2012 more than 1,800 companies participated from over 58 countries!!
- Made in Italy has once again distinguished thanks to the class and elegance of the display LUXOR DOUBLE

	KP12Q	KP12Q2	KD12Q2	KC12Q2
	+2 / +10	+2 / +10	-20 / +5	+14 / +16
	+30	+30	+30	+30
				
	70	70	60÷35	40÷44
	Ad aria/by air	Ad aria/by air	A gas caldo / by hot gas	Ad aria/by air
	n° 6 cm 41 x 107	n° 4 cm 41 x 107	n° 4 cm 41 x 107	n° 4 cm 41 x 107
	●	●	●	●
	811	536	536	536
	320/355	260/292	275/307	260/292
	1120	1120	1800	1120

Fluido refrigerante: R404A. Possibilità di carico per singolo ripiano in vetro fino a 20 kg.

Refrigerating fluid R404A. Possibility of loading up to 20 kg per shelf.

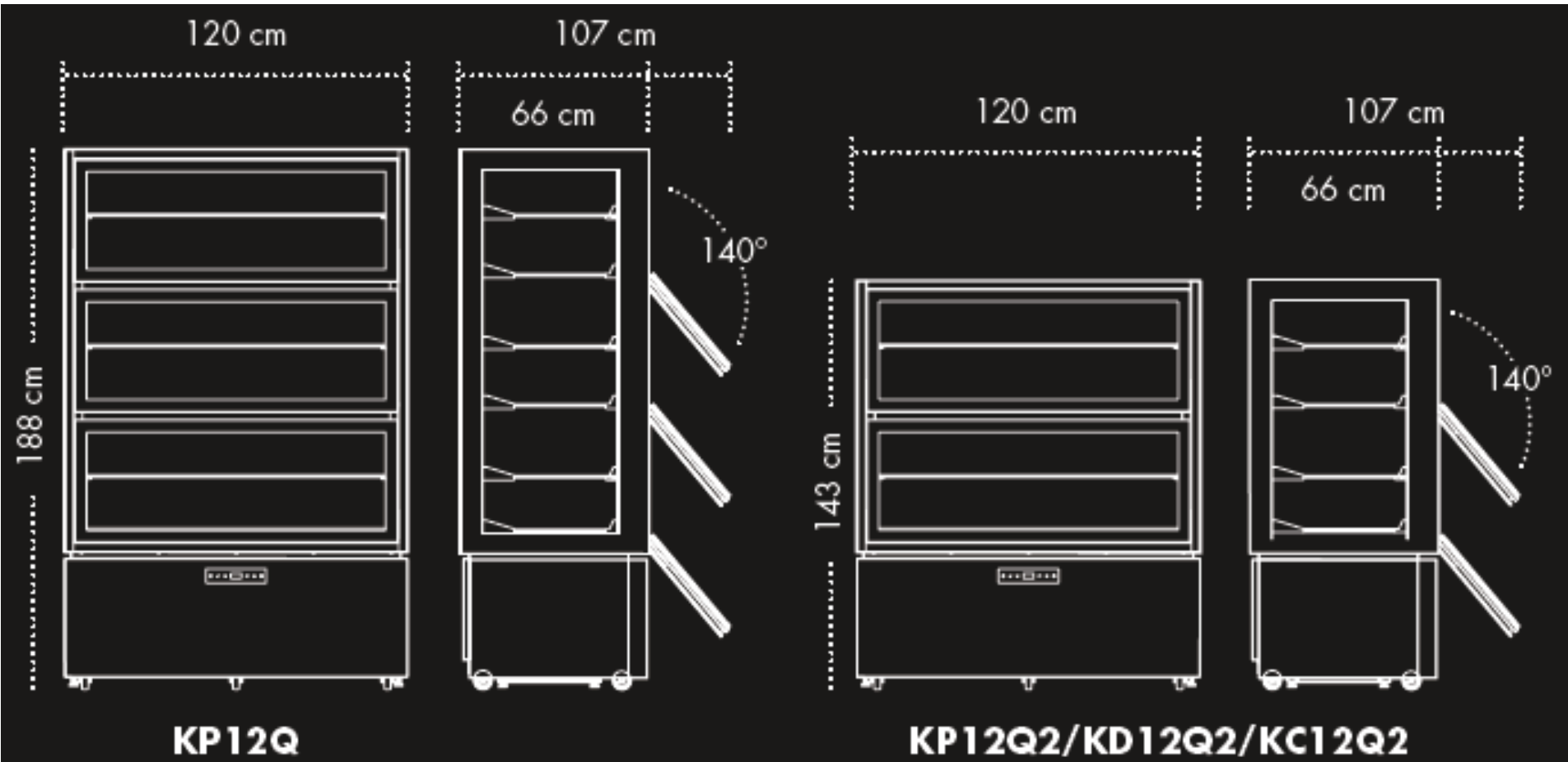

LUXOR DOUBLE BUILT IN

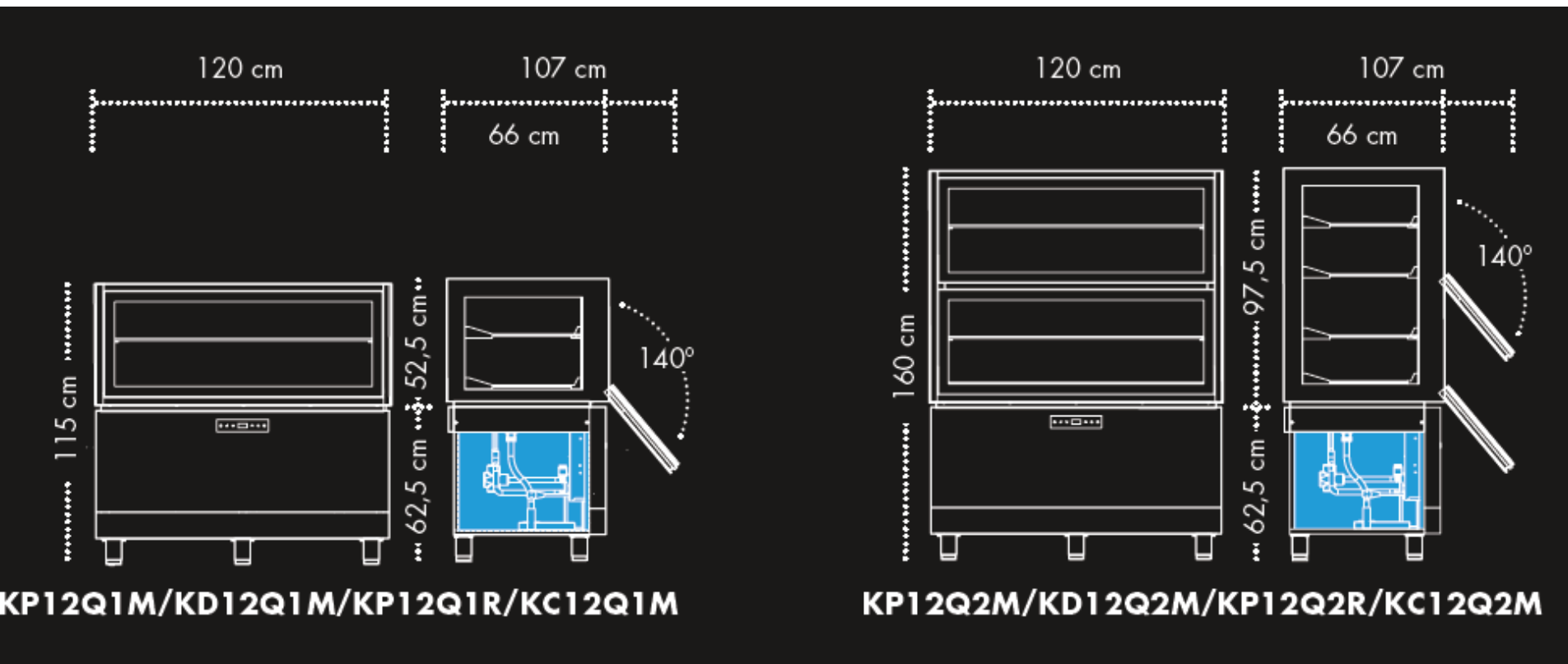

...R: preset for remote cooling unit
...M: with cooling unit integrated

Note: See Sagi instructions for the pannels